





## LAMPIRAN

 <p style="font-size: small;">Universitas Pembangunan Jaya</p>	<b>FORMULIR PEMBIMBINGAN SKRIPSI/TA</b>	SPT-1/03/SOP-28/F-03  No. Revisi: _____
---	---	---

Nama Mahasiswa : Muhammad Zidan Imaduddin  
 Prodi/NIM : Desain Produk / 201801013  
 Judul Skripsi/TA yang diajukan : Perancangan UI/UX Pada mesin POS Quinos Menggunakan Metode Gamifikasi guna Meningkatkan Produktivitas di Area Kasir CH160!

No	Tanggal	Materi Pembimbingan	Paraf Mhs	Paraf Dosen Pembimbing
1	12 Februari 2023	Konsultasi Latar Belakang	<i>[Signature]</i>	<i>[Signature]</i>
2	16 Maret 2023	Konsultasi bab 2	<i>[Signature]</i>	<i>[Signature]</i>
3	31 Maret 2023	Konsultasi bab 3	<i>[Signature]</i>	<i>[Signature]</i>
4	13 April 2023	Konsultasi Desain	<i>[Signature]</i>	<i>[Signature]</i>
5	5 Mei 2023	Asistensi sketsa	<i>[Signature]</i>	<i>[Signature]</i>
6	30 Mei 2023	Asistensi Sketsa Akhir	<i>[Signature]</i>	<i>[Signature]</i>
7	12 Juni 2023	Pembahasan Desain	<i>[Signature]</i>	<i>[Signature]</i>
8	3 Juli 2023	Perbaikan Mockup	<i>[Signature]</i>	<i>[Signature]</i>

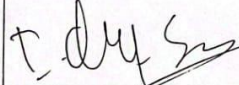
\* Jika pembimbingan lebih dari minimal 8 kali, mohon membuat salinan formulir ini

		
Mahasiswa	Dosen Pembimbing 1	Dosen Pembimbing 2

Copyright ©2020 Universitas Pembangunan Jaya. All rights reserved. | +62-21-7455555

Lampiran 1. Formulir bimbingan

TAMPAK ATAS  
1:1

TAMPAK SAMPING  
1:1

TAMPAK DEPAN  
1:1

 FAKULTAS TEKNOLOGI DAN DESAIN UNIVERSITAS PEMBANGUNAN JAYA		
DESAIN PRODUK		
NAMA		
MUHAMMAD ZIDAN IMADUDDIN		
NIM		
2018051013		
SEMESTER		
10		
MATA KULIAH		
TA		
JUDUL TUGAS		
-		
NAMA GAMBAR		
GAMBAR POTONG		
JUDUL GAMBAR		
GAMBAR POTONG MESIN POS		
PROYEKSI	SATUAN	SKALA
	CM	1:1
NO KOMPONEN	JML. LEMBAR	NO. LEMBAR
01		01
PARAF ASISTENSI		

Lampiran 2. Gambar potong

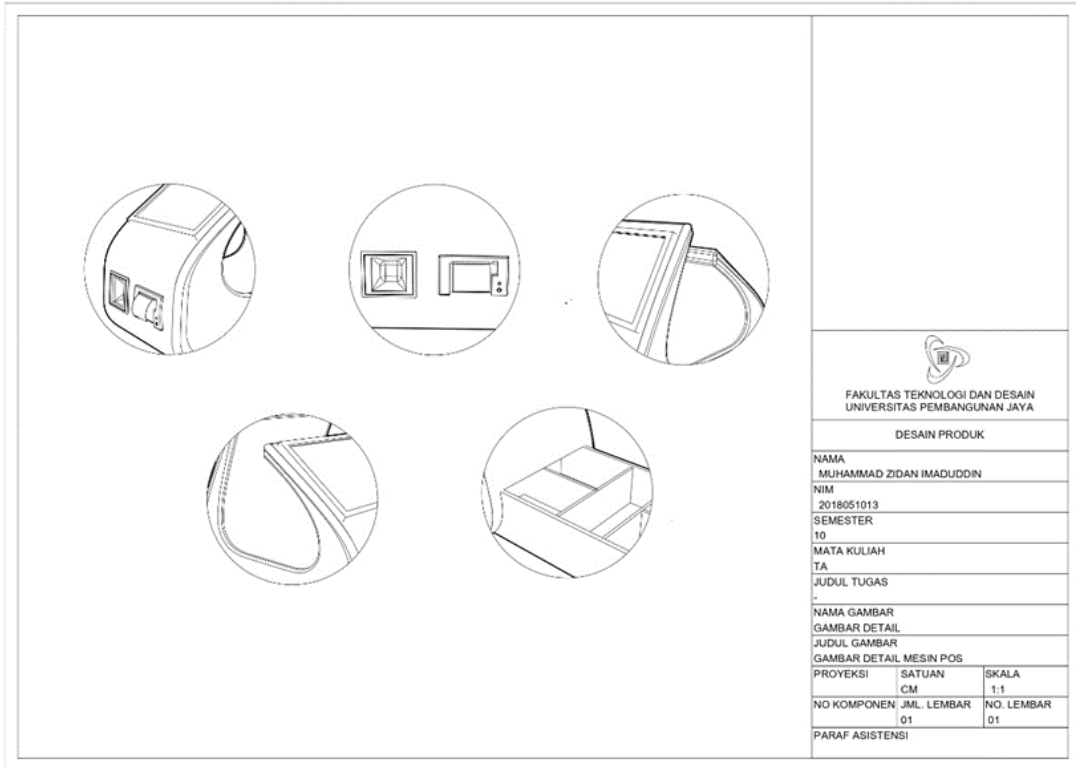

 FAKULTAS TEKNOLOGI DAN DESAIN UNIVERSITAS PEMBANGUNAN JAYA		
DESAIN PRODUK		
NAMA		
MUHAMMAD ZIDAN IMADUDDIN		
NIM		
2018051013		
SEMESTER		
10		
MATA KULIAH		
TA		
JUDUL TUGAS		
-		
NAMA GAMBAR		
GAMBAR DETAIL		
JUDUL GAMBAR		
GAMBAR DETAIL MESIN POS		
PROYEKSI	SATUAN	SKALA
	CM	1:1
NO KOMPONEN	JML. LEMBAR	NO. LEMBAR
	01	01
PARAF ASISTENSI		

Lampiran 3. Gambar detail

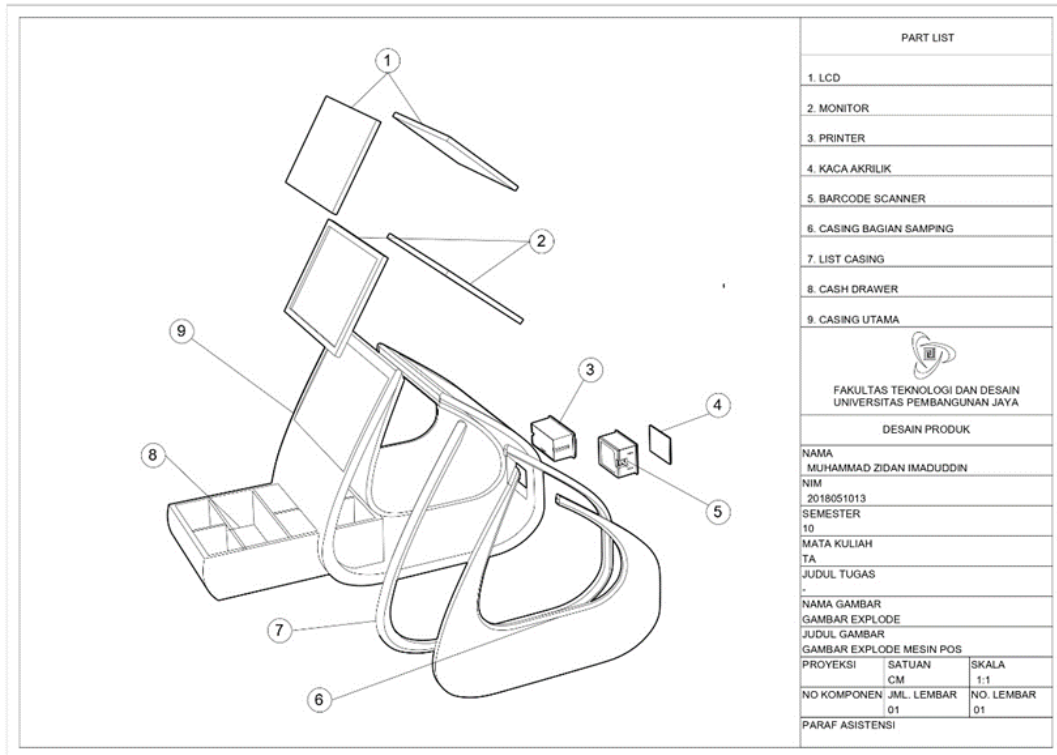

Lampiran 4. Gambar explode



Lampiran 5. Ilustrasi suasana

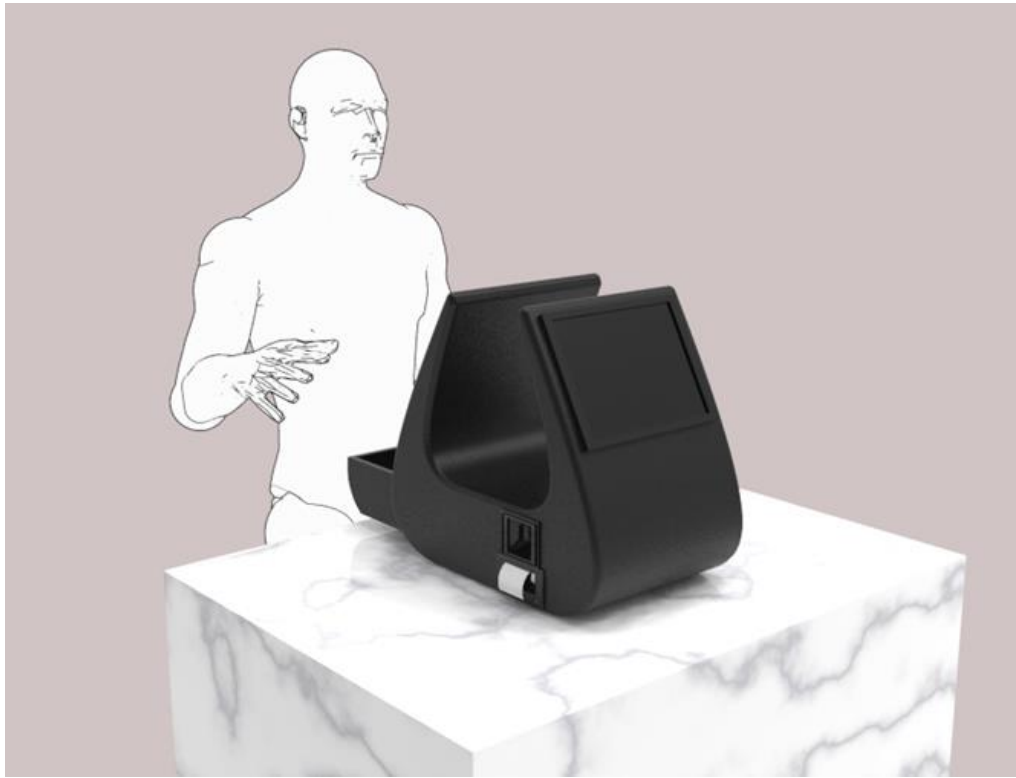

Lampiran 6. Ilustrasi pemakaian